



ARCADIS Orbic
ARCADIS Orbic 3D
Clinical Workflow and Surgical Precision at its Best

SIEMENS
medical

ARCADIS Bridging the borders





of the OR

Feel the impact

Discover the new generation of mobile C-arms from Siemens.

ARCADIS® is more than just a new C-arm. ARCADIS is an entirely new generation of C-arm technology that marks the start of a new era in the OR, offering completely new possibilities. ARCADIS integrates *syngo*®, the unique software platform for virtually all Siemens imaging systems, into your operating room. *syngo* allows virtually all imaging modalities and image-viewing workstations to use the same intuitive user interface for system operation, image postprocessing and overall networking. ARCADIS integrates modalities such as CT and MR into your clinical workflow as well as the overall network. With *syngo*, you can access all clinical patient information online, at the click of a button. In addition, *syngo* develops new synergies for clinical workflow and can decrease the training needs of the hospital staff. The result? Significantly increased efficiency in your OR.

Feel the impact!

ARCADIS Orbic

Clinical workflow



at its best



ARCADIS Orbic's software is designed to support the entire clinical workflow, from patient registration to image documentation.

The screenshot shows a 'Patient Registration' window with a blue header. It is divided into three main sections: PATIENT, PROCEDURE, and HOSPITAL. The PATIENT section includes fields for Last name (Doe), First name (Jane), Middle name, Title (Prof., Suite L), Other Patient Name(s), Other Patient ID(s), Patient ID (123456), Date of Birth (05/1955), Sex (Male, Female, Other), Age (49 years), Height (139"), Weight (80), and Additional info. The PROCEDURE section includes Accession No (678), Request ID (123), Requested procedure(s), Study list, and Study (obese patient). The HOSPITAL section includes Institution name (St. Jeronius Hospital), 1. Performing physician (Dr. Cook), 2. Performing physician (Dr. Janssen), 1. Operator (Dr. Gray), and 2. Operator (Dr. Hansen). At the bottom, there are buttons for Emergency, Help, Search, Cancel, Exam, and Register.

Optimal workflow for patient registration:

With *syngo*, ARCADIS Orbic supports all DICOM 3.0 functions, seamlessly integrating your data management process into the HIS/RIS world, beginning with patient registration. You can thereby transfer all patient data directly from the hospital information system to your worklist, or query the archive for "patient search". Patient pre-registration significantly reduces your OR prep time. ARCADIS Orbic also fully supports emergency registrations.

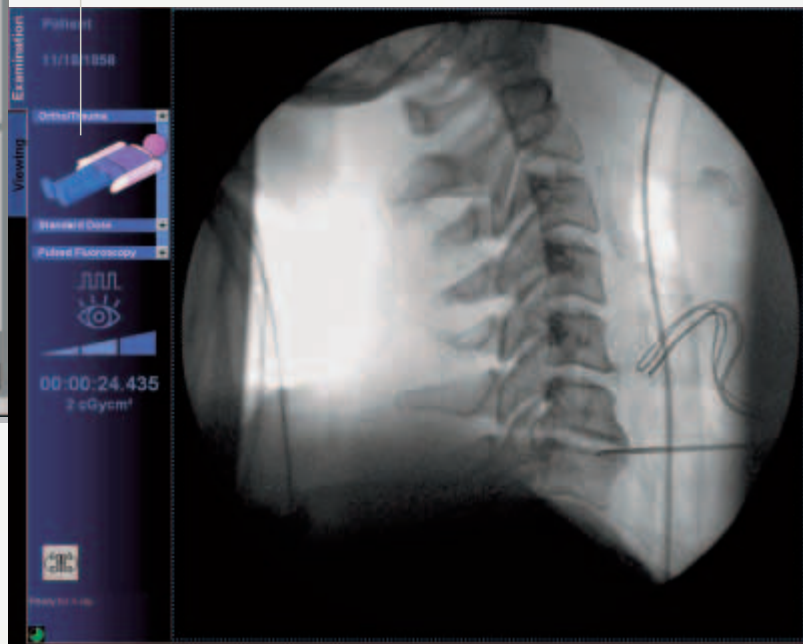

Optimal workflow during examinations:

ARCADIS Orbic supports the full range of X-ray-based applications in the OR. The "Examination" task card provides you with a large range of medical applications, from orthopedic and trauma surgery to vascular surgery and beyond. The specific program within these applications is intuitively selected using VPA (Virtual Patient Anatomy). Simply click on the VPA body region to be examined to select the appropriate, optimized application program. Up to 200 dedicated, application-specific programs are available. In addition, ARCADIS Orbic's three-level dose rate concept allows you to precisely adjust the dose to the required levels.

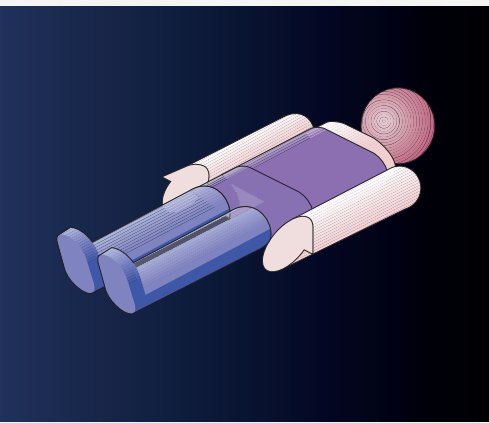

VPA (Virtual Patient Anatomy) for the selection of the body region to be examined

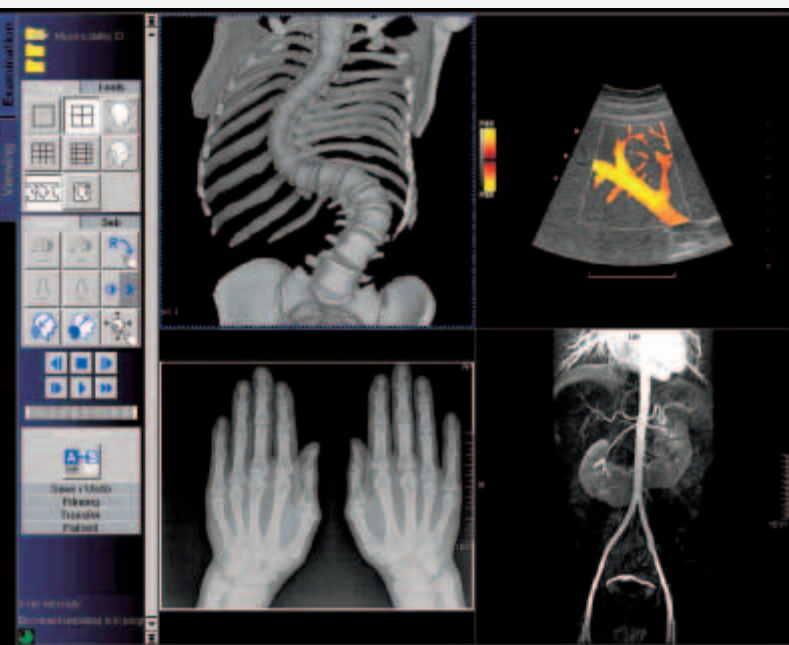

Optimal workflow with multi-modality viewing:

Multi-modality viewing (Query/Retrieve) allows you to access images from other modalities, such as CT and MR, before, during or after the OR procedure. The monitor cart acts as an OR workstation providing you with virtually all of the necessary image information, making light boxes obsolete. ARCADIS Orbic's self-explanatory icons bring the image postprocessing capabilities of syngo to your OR staff with ease.

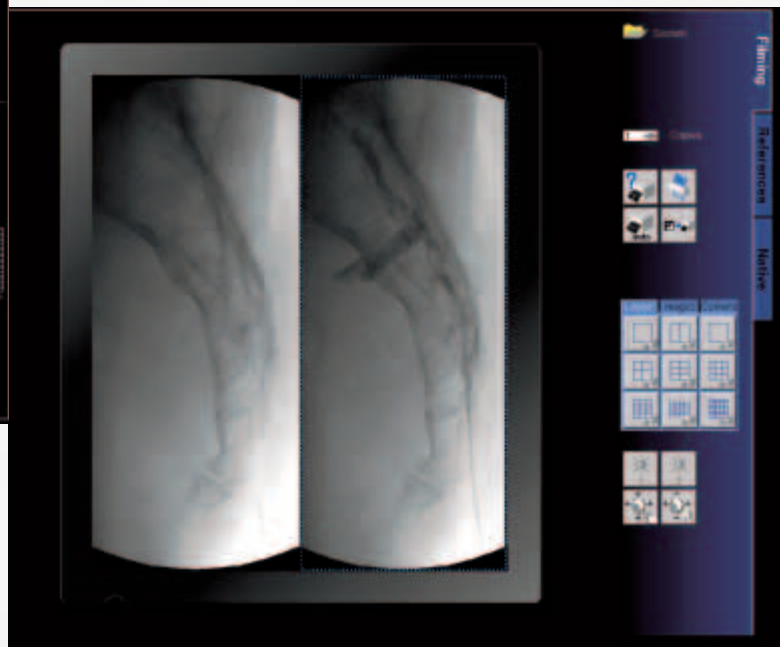

Optimal workflow for documentation and archiving:

ARCADIS Orbic has a local storage capacity of 40,000 images, offering you increased flexibility. A CD burner is provided for local long-term storage in DICOM or BMP formats. Naturally, you can also use DICOM to send your images to the archive or to a network printer. Network printing is facilitated by the virtual film sheet, which allows you to view images before printing and arrange them as desired.

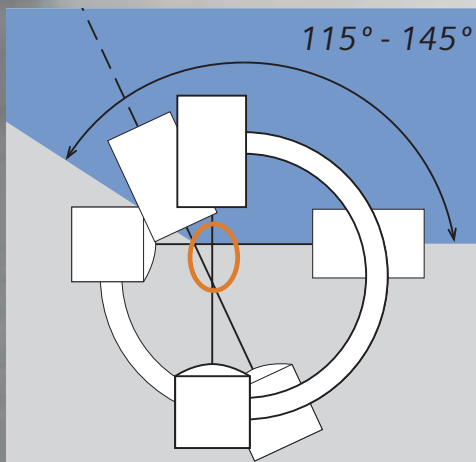

Non-isocentric design:

- The central beam moves out of the isocenter, making repositioning necessary.
- Repositioning of the C-arm is time-consuming and can lead to additional radiation exposure
- The distance between the image intensifier or X-ray tube and the body region being imaged varies with each change of the orbital movement.
- The image size thus varies for different projections
- The orbital movement is restricted to 25° to 55° degrees of "overscan", depending on C-arm model and manufacturer

ARCADIS Orbic

True isocentricity makes a difference



ARCADIS Orbic has distinctive features which add up to a clinical efficiency unparalleled by any other mobile C-arm:

- **Industry-exclusive true isocentric orbital movement** enables time and dose savings by eliminating readjustments, especially for examinations involving several different projections.
- **Industry-leading 190° orbital movement with 95° overscan** enable virtually unrestricted positioning options for any projection which may be required.

Conventional C-arms require adjustment of the C-arm when changing the projection angle. ARCADIS Orbic features an isocentric design which ensures that the anatomy being imaged always remains in the center of rotation (isocenter) of orbital and angular movements. Therefore, ARCADIS Orbic requires no horizontal or vertical readjustment in order to keep the field of view centered – for example, after changing from an AP to a lateral view.

The result is improved workflow and the elimination of time-consuming and troublesome repositioning. Especially important in spine surgery and pain management, the isocentric design and large overscan ($\pm 95^\circ$) of ARCADIS Orbic enables precise views in a very time-efficient manner. Less repositioning can also translate into substantial dose savings for both OR personnel and patients.

Additionally, isocentricity sets the stage for efficient 3D intra-operative imaging with a mobile C-arm. ARCADIS Orbic was designed that all existing and future ARCADIS Orbic systems can be upgraded to 3D imaging functionality.

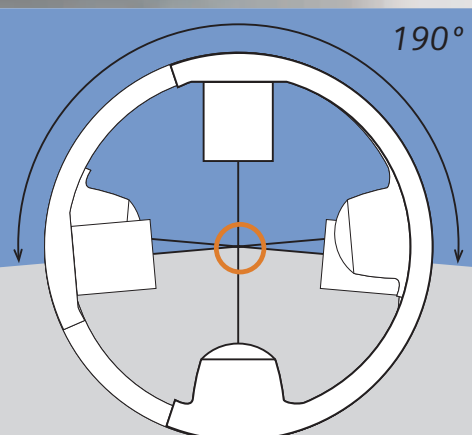

Isocentric design:

- *The central beam always remains in the isocenter, eliminating the need for repositioning and enabling both time and dose savings*
- *The distance between the image intensifier or X-ray tube and the body region being imaged always remains the same, thus ensuring a constant image size with varying projections*
- *Large orbital rotation of up to 190° (+95°/-95°)*
- *Prerequisite for 3D imaging via orbital movement*

Brilliant 1K² image quality throughout the entire imaging chain

ARCADIS Orbic was designed with the highest standard of image quality in mind. This unique C-arm is equipped with a **fully digital 1024 x 1024 (1K²) imaging chain**, covering everything from image acquisition to image processing and documentation. Like all X-ray-based products from Siemens, the individual components of the entire image chain are from one source – Siemens. These ideally matched components allow ARCADIS Orbic to consistently deliver the best possible image quality.

High performance for demanding applications

ARCADIS Orbic delivers tube currents of up to 23 mA, which means that you are prepared for virtually any application. The enhanced “Power Mode” is available at the touch of a button when you need it most – for example, imaging the pelvis or the dense region between the pelvis and spine.

Best image quality from nearly any angle

ARCADIS Orbic is equipped with large, flicker-free TFT flat screens – available either in color or monochrome. These TFT displays feature high-brightness and high-contrast, as well as a viewing angle of 170°, both horizontally and vertically. The monochrome version provides exceptionally high brightness.



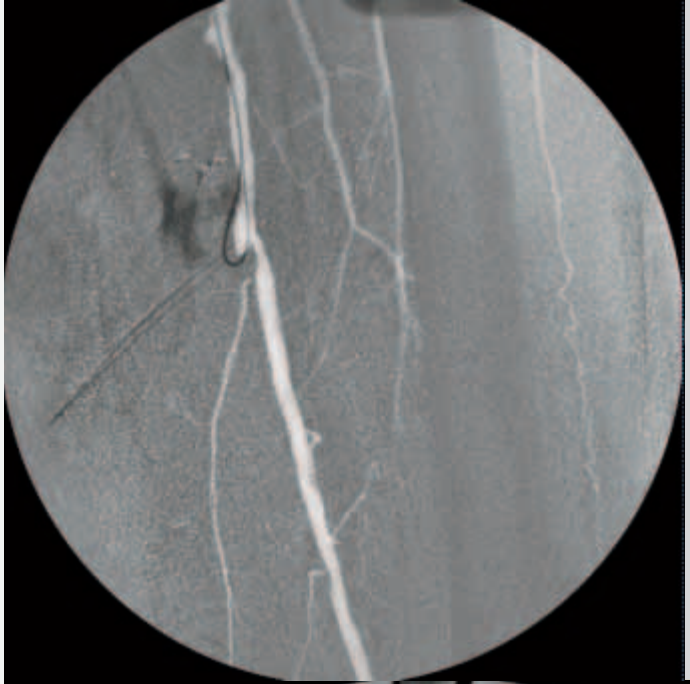
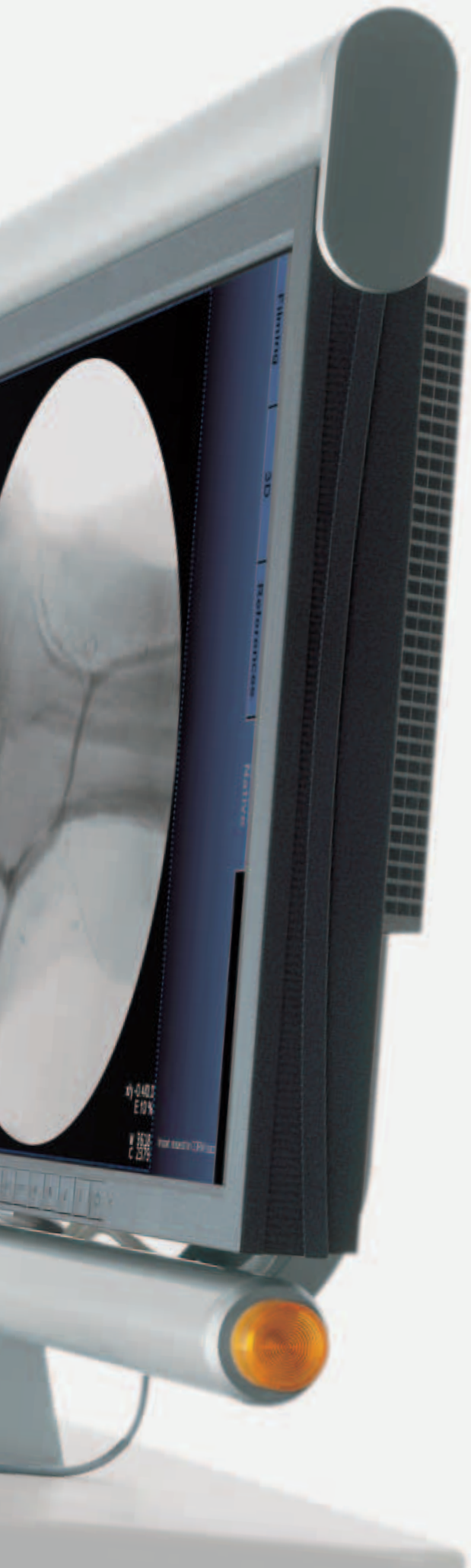

1K2

DICOM – through and through





Networking

ARCADIS Orbic:

Key DICOM functionalities

The unique *syngo* software platform supports virtually all DICOM functionalities, such as DICOM Send/Receive, DICOM Storage Commitment, DICOM Print, DICOM Worklist, DICOM Query/Retrieve, DICOM MPPS.

ARCADIS Orbic allows you to access the entire clinical network, directly from the OR – regardless of the manufacturers involved.



DICOM Send/Receive
DICOM Storage Commitment
DICOM Print
DICOM Worklist
DICOM Query/Retrieve
DICOM MPPS

*IT systems in the hospital,
global network (PACS, RIS, HIS),
network printer, archive*

Navigation

ARCADIS Orbic and NaviLink 2D:

A new standard for surgical navigation

ARCADIS Orbic features an integrated digital 1K² navigation interface with automatic image transfer. For better image quality, 2D images are now transferred in digital 1K² format, significantly increasing the accuracy of surgical navigation. NaviLink™ 2D is compatible with the navigation systems of leading manufacturers and is synchronized for optimal clinical workflow.



NaviLink 2D (DICOM)

Navigation systems

syngo DICOM Viewer on CD:

The interface for your PC

While burning your DICOM images to CD, you can store the *syngo* DICOM Viewer along with the images. Now you can view and evaluate your images directly on the PC using the same familiar *syngo* user interface.

CD-ROM



DICOM- or BMP format

CD writer including syngo DICOM Viewer

Remote Diagnostics:

Our service for maximum availability

ARCADIS Orbic is fully integrated in Siemens Remote Services (SRS). What does this mean for you? A service organization that is proactive rather than reactive – and is therefore especially effective. The secret of our success is that SRS operates in the background, locating possible sources of trouble and eliminating them before they lead to malfunctions.

Remote Services

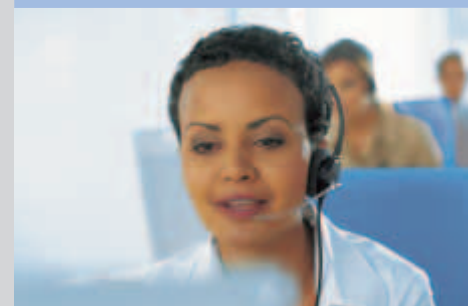

Siemens Remote Services

Easy and convenient handling

ARCADIS Orbic also offers clear advantages with easy and convenient handling.

Mobility: safe and easy

The excellent maneuverability of ARCADIS Orbic is supported by an ergonomically shaped steering handle. The simple steering mechanism ensures maximum mobility.

In addition to its attractive design, the monitor cart is easy to move. Its large, ergonomic handles enable precise and secure handling, while the TFT flat screens allow for an unobstructed view during transport. And, in addition to the integrated cable deflectors on the cart wheels, the monitor cart also features locking wheel brakes for secure immobilization.

Handling: nothing could be easier

ARCADIS Orbic's concealed cables give the system a very neat appearance and permit extremely fast and easy aseptic preparation and post-operative cleaning of its surfaces. A sterile environment is much easier to prepare and maintain without any interference from exposed cables. This feature is another example of how ARCADIS Orbic improves your clinical workflow.

Color coding: simply clever

In order to facilitate your daily work, ARCADIS Orbic incorporates a special color-coded design of the handles and C-arm movements. The pushbuttons for the electromagnetic brakes are color-coded and matched with an identical colored measurement scale or colored marking for each movement. These color codes serve as an easy-to-understand and efficient orientation for the OR staff, allowing fast and precise positioning of the C-arm.

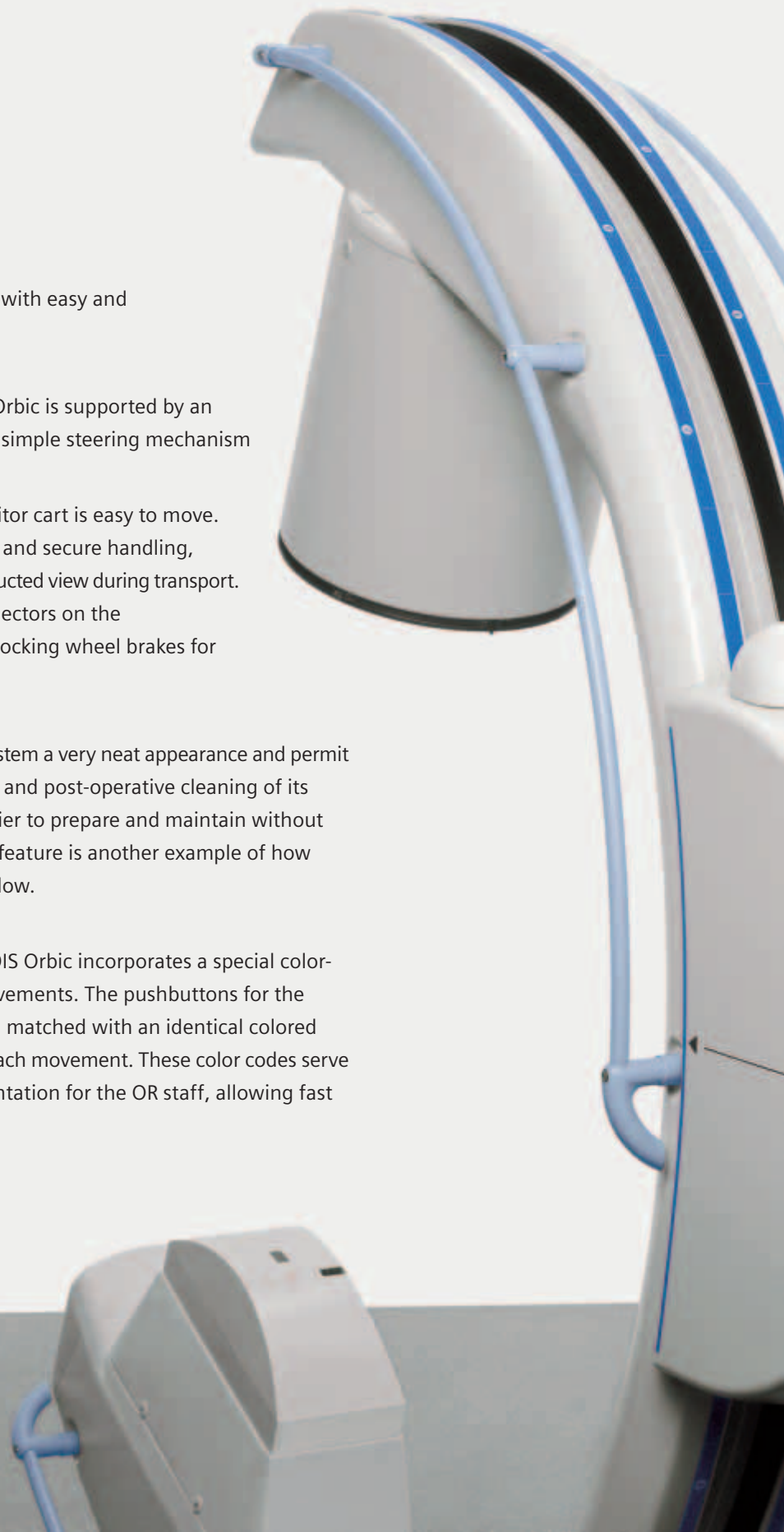



ARCADIS Orbic 3D – Intra-operative 3D imaging for increased precision in the OR





Some of the greatest challenges in trauma and orthopedic surgery are the identification and repositioning of fractures, placement of pedicle screws in the spine, and verifying accurate placement of fixation devices.

For example, placing a screw too close to a joint can lead to extremely painful post-traumatic complications that may require further surgical intervention.

2D projection imaging via conventional C-arms does not always offer enough information to precisely check these interventions and prevent such complications. Furthermore, CT or MR equipment is not commonly available in the operating room.

ARCADIS Orbic 3D provides the answer in a single mobile C-arm with intra-operative 3D multiplanar imaging. Thanks to the generation of 3D image data directly in the OR and the resulting possibility of 3D navigation, this system can make surgical interventions safer and more precise than ever before.

Intra-operative 3D imaging with ARCADIS Orbic 3D is based on ARCADIS Orbic, with its isocentric design and 190° orbital movement that provide the prerequisites for 3D imaging.

The application of intra-operative 3D imaging with ARCADIS Orbic 3D is ideally suited to the following body regions:

- **Bones and joints of the upper and lower extremities**
- **Cervical, thoracic and lumbar spine**
- **Pelvis/hip**
- **Maxillofacial**

3D imaging workflow with ARCADIS Orbic 3D

- The body region being imaged is positioned in the isocenter with the help of laser light localizers
- A radiation-free manual test run is then performed to ensure that the unit will not collide with other objects during the automated scan
- The automatic 190° scan is then initiated via the foot switch
- ARCADIS Orbic 3D requires only **30 or 60 seconds** for the exposure of 50 or 100 **2D images in 1K² resolution**
- The 3D dataset, **a cube with a volume of approximately 12 cm x 12 cm x 12 cm**, is progressively generated throughout the scan and displayed on the right monitor
- The **correct position** of the reconstructed dataset can be **monitored during the scan**
- The complete 3D image data is **available immediately** after the scan
- The 3D image data is displayed as multiplanar reconstructions (MPRs) in coronal, sagittal and axial projections
- Clinicians can review, individually align and evaluate the reconstructed 3D dataset on the right monitor in all three spatial directions. The corresponding 50 or 100 individual **2D images** are displayed in **brilliant 1K² image quality** on the left monitor.

**ARCADIS Orbic 3D –
brilliant intra-
operative
3D imaging and
effortless workflow**

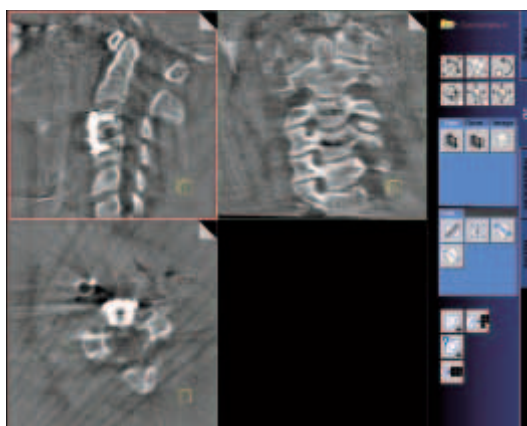
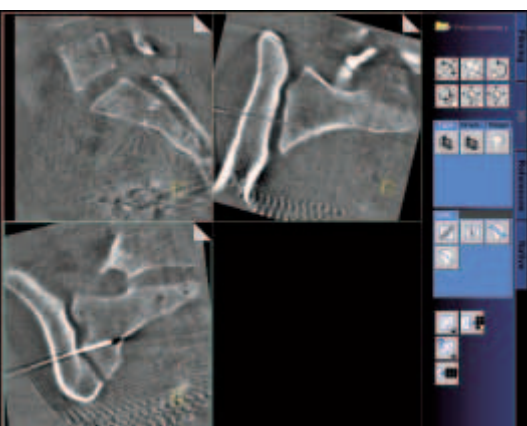



Important considerations for intra-operative 3D imaging:

The CT-like reconstruction principle of ARCADIS Orbic 3D requires metal-free OR tables and positioning accessories to avoid artifacts in the reconstructed 3D dataset. Tables with carbon-fiber tops and accessories offer unobstructed 3D imaging and are commonly available.

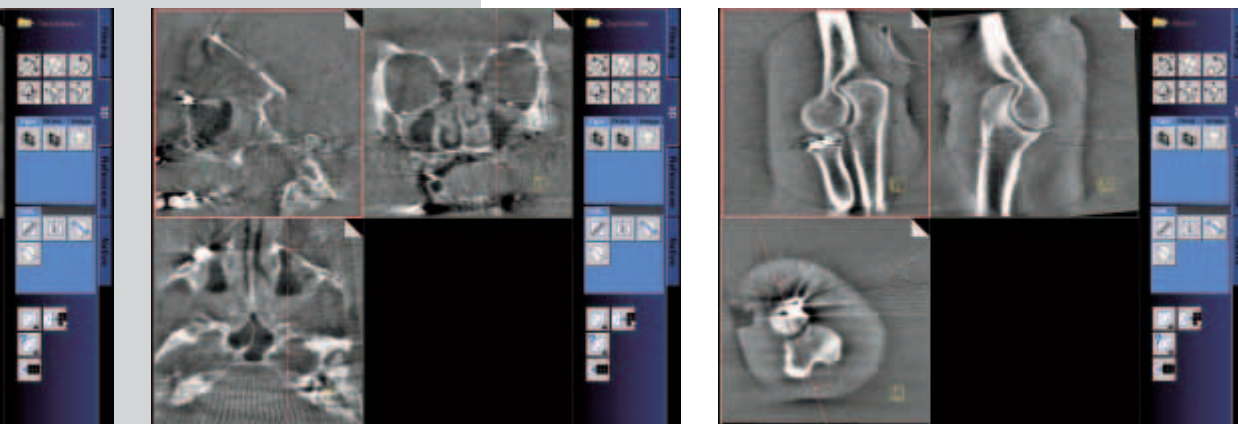
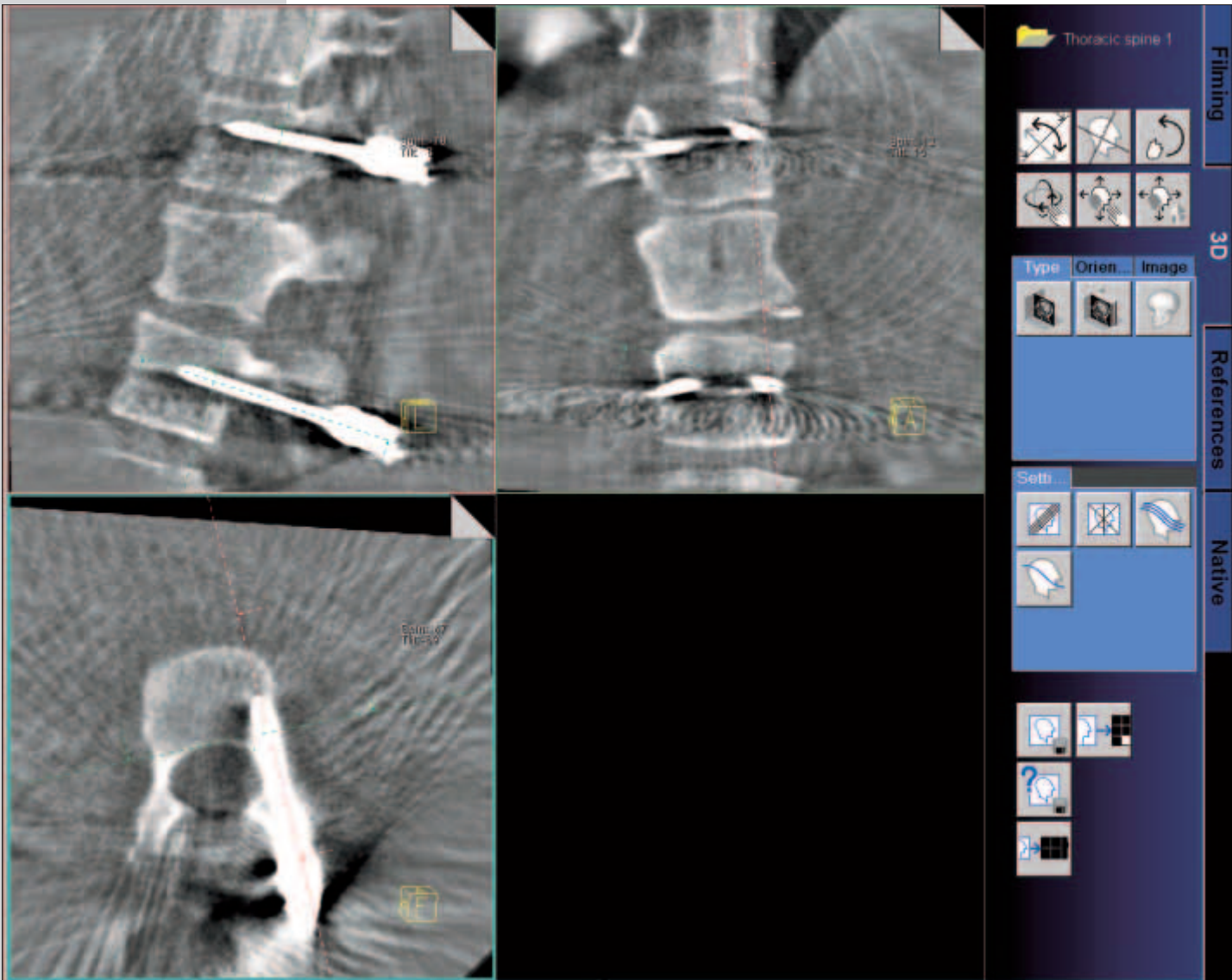

NaviLink 3D and ARCADIS Orbic 3D

A strong combination in surgical navigation

NaviLink™ 3D provides a direct 3D navigation interface for ARCADIS Orbic 3D. This interface combines the intra-operative 3D imaging of a mobile C-arm with high-precision surgical navigation. ARCADIS Orbic 3D enables both pre-operative and intra-operative 3D imaging with the patient in the most current surgical position. The acquired 3D image data is optimally suitable for direct surgical navigation. The corresponding spatial coordinates are assigned to the image data, which are then automatically transferred to the navigation system without any further processing steps. As a result, manual alignment of the anatomy to the 3D images is no longer required. The accuracy of the surgical navigation is thus increased considerably and the clinical workflow is greatly optimized. In addition, 3D image data acquisition can be repeated as often as necessary to account for any anatomical changes which may occur in the OR field during surgery.

Functionality of NaviLink 3D

A reference ring is attached to the image intensifier for automatic navigation registration. The manufacturers of the navigation systems have adapted their marker rings to our reference ring in a way that the marker ring is always located in the same position. During system installation, a calibration matrix is calculated and stored in the ARCADIS Orbic 3D. The calibration matrix automatically supplies the relation between the coordinates of the C-arm and the image coordinates in space. These image coordinates and the 3D dataset are transferred to the navigation system and provide direct coupling with the position of the navigation instruments. Manual navigation registration is no longer required and surgical intervention can begin immediately after 3D image data acquisition with ARCADIS Orbic 3D.

Open interface

NaviLink 3D represents an open and universal interface for navigation systems from various providers. NaviLink 3D is currently compatible with navigation systems offered by BrainLAB, Medtronic, Praxim and Stryker.



By offering excellent 3D image quality and automatic navigation registration, NaviLink3D and ARCADIS Orbic 3D continue the high standard Siemens has set for precision and workflow in surgical navigation.

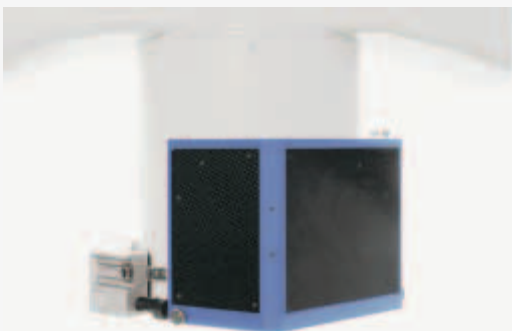

With ARCADIS Orbic 3D and NaviLink 2D, surgical navigation is possible in 2D as well.

ARCADIS Orbic

ARCADIS Orbic 3D – Clear advantages in clinical workflow and surgical precision

syngo speaking

- Uniform, intuitive user interface for system operation, image post-processing and networking
- Workflow-oriented task card structure
- Comprehensive connectivity with other modalities and clinical networks

Optimized clinical workflow

- Maximum flexibility in patient registration
- Easy, intuitive selection of application-specific programs with VPA (Virtual Patient Anatomy)
- Virtually unlimited possibilities for documentation and archiving

Brilliant 1K² image quality

- Optimally matched, continuous 1K² imaging chain from image acquisition to viewing and archiving
- High tube currents of up to 23mA through enhanced "Power Mode"
- Large high-brightness, high-contrast TFT flat screens

Distinctive design

- Time and dose savings through isocentric design, no readjustments required
- High flexibility and virtually unlimited projection possibilities through 190° rotation
- Outstanding handling through electromagnetic brakes and ergonomic handles
- Intelligent color coding for fast and precise positioning and operation

Comprehensive connectivity and specialized interfaces

- Support of virtually all DICOM 3.0 functionalities
- Integrated, digital 1K² navigation interface NaviLink 2D with automatic transfer of 2D images in 1024 x 1024 resolution for surgical navigation
- syngo DICOM Viewer for convenient selection and viewing of clinical images on the PC

In addition, ARCADIS Orbic 3D features:

Intra-operative 3D imaging

- Integrated 3D imaging function for intra-operative application to increase safety and precision
- Acquisition of the 3D dataset in only 30 or 60 seconds
- The correct position of the reconstructed dataset can be monitored during the exposure
- 2D and 3D image data can be viewed simultaneously on the monitor cart

Direct navigation interface NaviLink 3D

- Shorter preparation phase through automatic registration and elimination of pre-operative imaging for navigation
- Automatic 3D image data transfer to the navigation system following the 3D scan
- Universal interface for navigation systems from various providers, e.g. BrainLAB, Medtronic, Praxim and Stryker

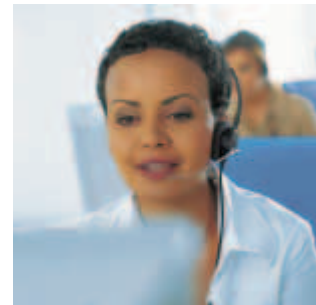

 **Proven Outcomes.**
This is what Siemens is helping to deliver right now. Outcomes that result from truly efficient workflow. Outcomes that improve your bottom line. Outcomes that lead to a level of care that feels exceptional to the patient and the care provider. Proof positive of the value of integrating medical technology, IT, management consulting and services. In a way that only Siemens can.



The continuous development of your skills,
productivity and technology **Life** is all about.

Life is the unique customer care solution from Siemens that helps you get the most from your investment.

Evolve is part of Life and our obsolescence protection program that helps you move to the next level of productivity and profitability. It covers the critical issue of staying on top of software and computer hardware upgrades and updates.

Through our Evolve packages and service contracts, you'll benefit from the latest workflow improvement, clinical application, and diagnostic function, in addition to the most advanced computer technology. These updates and upgrades result in shorter examination times, enhanced productivity, and optimal system performance at all times.

On account of certain regional limitations of sales rights and service availability, we cannot guarantee that all products included in this brochure are available through the Siemens sales organization worldwide. Availability and packaging may vary by country and is subject to change without prior notice. Some/All of the features and products described herein may not be available in the United States.

The information in this document contains general technical descriptions of specifications and options as well as standard and optional features which do not always have to be present in individual cases.

Siemens reserves the right to modify the design, packaging, specifications and options described herein without prior notice. Please contact your local Siemens sales representative for the most current information.

Note: Any technical data contained in this document may vary within defined tolerances. Original images always lose a certain amount of detail when reproduced.

Please find fitting accessories:
www.siemens.com/medical-accessories

Siemens AG
Wittelsbacherplatz 2
D-80333 Muenchen
Germany

Headquarters

Siemens AG, Medical Solutions
Henkestr. 127, D-91052 Erlangen
Germany
Telephone: +49 9131 84-0
www.siemens.com/medical

Contact addresses:

In the USA

Siemens Medical Solutions USA, Inc.
51 Valley Stream Parkway
Malvern, PA 19355
Telephone: +01 610 448 4500
Telefax: +01 610 448 1620

In Japan

Siemens-Asahi
Medical Technologies Ltd.
Takanawa Park Tower 14F
20-'D014, Higashi-Gotanda 3-chome
Shinagawa-ku
Tokyo 141-8644
Telephone: +81 3 5423 8489

In Asia

Siemens Medical Solutions
Asia Pacific Headquarters
c/o Siemens Advanced Engineering
Pte Ltd.
Block 28 Ayer Rajah Crescent
No. 06-'D008
Singapore 139959
Telephone: +65 8715888

In Germany

Siemens AG, Medical Solutions
Special Systems
Allee am Röthelheimpark 2
D-91052 Erlangen
Germany
Telephone: +49 9131 84-0
www.siemens.com/surgery

Siemens **Medical**
Solutions that help